

RF POWER TRIODE

QUICK REFERENCE DATA						
Frequency (MHz)	C teleg. grounded grid		Industrial oscillator class C			
			DC operation		AC operation	
	V _a (V)	W _o (W)	V _a (V)	W _o (W)	V _{tr} (V)	W _o (W)
470	2000	595	2000	480	1800	230
640	1800	490				
730	1800	460				
810	1800	408	1800	284		

HEATING: direct; filament thoriated tungsten

Frequency	f	< 600	600 to 750	750 to 900	MHz
Filament voltage	V _f	= 3.4	3.3	3.2	V
Filament current	I _f	= 19	-	-	A

CAPACITANCES

Anode to all except grid	C _a	<	0.12	pF
Grid to all except anode	C _g	=	11.5	pF
Anode to grid	C _{ag}	=	6.5	pF

TYPICAL CHARACTERISTICS

Anode voltage	V _a	=	2000	V
Anode current	I _a	=	200	mA
Amplification factor	μ	=	33	
Mutual conductance	S	=	10	mA/V

TEMPERATURE LIMITS (Absolute limits)

Temperature of seal between filament terminals = max. 200 °C

Temperature of other seals = max. 250 °C

Table 1 Cooling characteristics

W_a (W)	h (m)	t_i (°C)	q_{min} (m ³ /min)	ΔP (Pa)*
400	0	45	0.65	12
	1500	35	0.65	12
	3000	25	0.65	12

The required quantity of air is independent of the anode dissipation and the frequency.

MECHANICAL DATA

Dimensions in mm

Net weight: 157 g

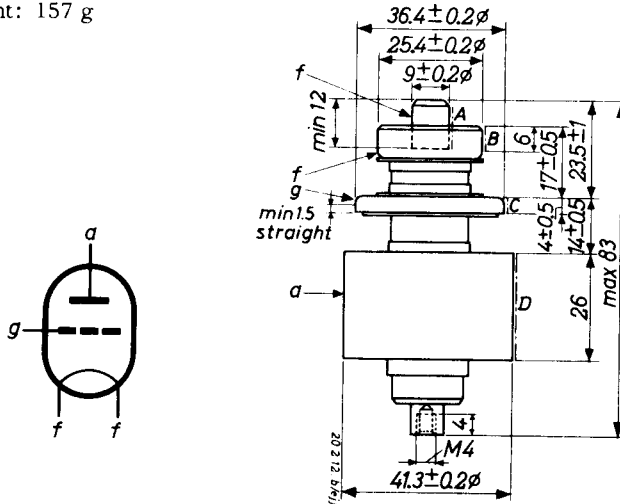

Fig. 1 Mechanical outline.

Eccentricity of the electrode connections: The electrode connections A, B and C are within cylindrical surfaces having a diameter of 9.5, 25.9 and 36.9 mm respectively and being concentric with the cylindrical surface D.

Mounting position: vertical with the anode up or down.

* 1 Pa \approx 0,1 mm H₂O.

RF CLASS C OSCILLATOR FOR INDUSTRIAL USE

LIMITING VALUES (Absolute limits)

Frequency	f	up to	470	900	MHz
Anode voltage	V_a	= max.	2200	2000	V
Anode current	I_a	= max.	400	400	mA
Anode input power	W_{i_a}	= max.	880	800	W
Anode dissipation	W_a	= max.	400	400	W
Negative grid voltage	$-V_g$	= max.	300	300	V
Grid current, loaded	I_g	= max.	120	120	mA
Grid current, unloaded	I_g	= max.	130	130	mA
Grid circuit resistance	R_g	= max.	10	10	k Ω

OPERATING CONDITIONS

Frequency	f	=	470	810	MHz
Anode voltage	V_a	=	2000	1800	V
Anode current, loaded	I_a	=	380	380	mA
Anode current, unloaded	I_a	=	170	-	mA
Grid circuit resistance	R_g	=	1000	1000	Ω ¹⁾
Grid current, loaded	I_g	=	110	110	mA
Grid current, unloaded	I_g	=	120	120	mA
Anode input power	W_{i_a}	=	760	684	W
Anode dissipation	W_a	=	280	400	W
Tube output power	W_o	=	480	284	W
Tube efficiency	η	=	63	41	%
Output power in the load	W_ℓ	=	340	200	W

¹⁾ The grid circuit resistance is obtained by a current stabilising device. The stated value applies to loaded conditions.

RF CLASS C OSCILLATOR FOR INDUSTRIAL USE in grounded grid circuit
with self rectification

LIMITING VALUES (Absolute limits)

Voltages with respect to cathode

Frequency	f	up to	470	MHz
Transformer voltage	V_{tr}	=	max. 2000	V(RMS)
Anode current	I_a	=	max. 210	mA
Anode input power	W_{i_a}	=	max. 450	W
Anode dissipation	W_a	=	max. 170	W
Negative grid voltage	$-V_g$	=	max. 300	V
Grid current, loaded	I_g	=	max. 85	mA
Grid current, unloaded	I_g	=	max. 120	mA
Grid circuit resistance	R_g	=	max. 5	k Ω

OPERATING CHARACTERISTICS

Voltages with respect to cathode

Frequency	f	=	470	MHz
Transformer voltage	V_{tr}	=	1800	V(RMS)
Anode current, loaded	I_a	=	190	mA
Anode current, unloaded	I_a	=	110	mA
Grid current, loaded	I_g	=	70	mA
Grid current, unloaded	I_g	=	100	mA
Grid circuit resistance	R_g	=	400	Ω
Anode input power	W_{i_a}	=	380	W
Anode dissipation	W_a	=	150	W
Tube output power	W_o	=	230	W
Tube efficiency	η	=	60	%
Output power in the load	W_l	=	160	W

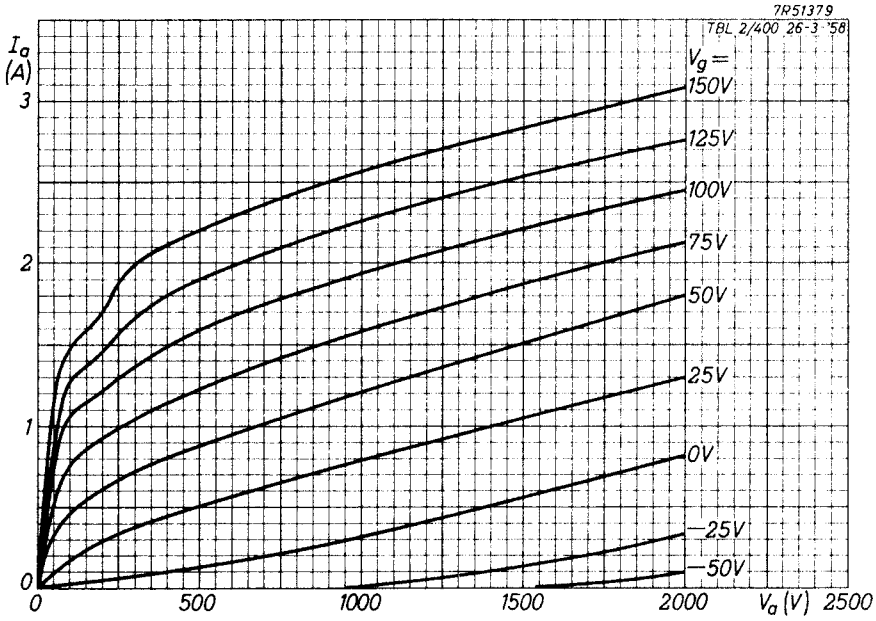

Fig. 2 I_a/V_a characteristics.

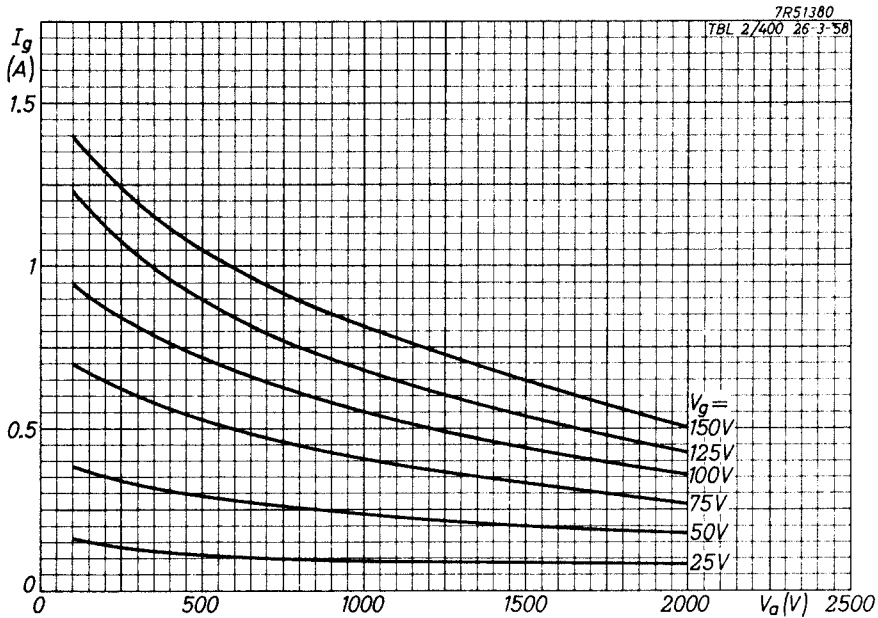

Fig. 3 I_g/V_a characteristics.

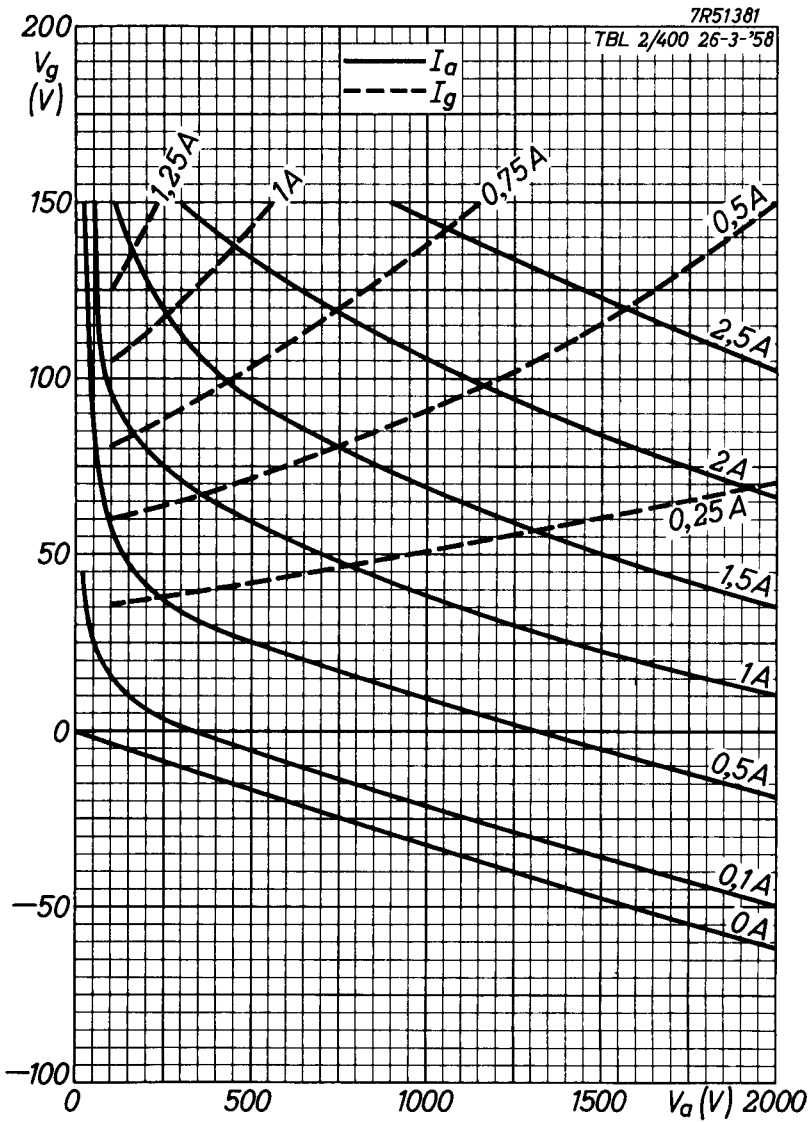

Fig. 4 Constant current characteristics.

PHILIPS

Data handbook



Electronic
components
and materials

TBL2/400

page	sheet	date
1	99	1988.02
2	100	1988.02
3	101	1988.02
4	102	1988.02
5	103	1988.02
6	104	1988.02
7	FP	2000.09.16