

# RCA-6883B/8032A/8552

## BEAM POWER TUBE

Controlled Zero-Bias  
Plate Current  
Controlled Power Output  
at Reduced Heater Voltage

85 Watts CW Output (ICAS) at 60 Mc  
50 Watts CW Output (ICAS) at 175 Mc  
RCA "Dark Heater" with  
10- to 16-volt Range

3-13/16" Max. Length  
1-21/32" Max. Diameter  
Octal 8-Pin Base  
Small, Sturdy Structure

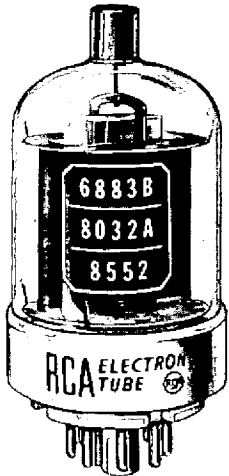

RCA-6883B/8032A/8552 is a small, sturdy, beam power tube having high efficiency and high power sensitivity for use in mobile and stationary equipment. It is rated as an af power amplifier and modulator, a linear rf power amplifier, and a Class C rf power amplifier and oscillator

The 6883B features a heater designed to operate over a voltage range of 12 to 15 volts and which will take excursions from 10 to 16 volts in battery operation. The heater design insures dependable performance in mobile equipment under operating conditions during battery charging and discharging. See *Special Performance Data* on page 4 for information covering heater overvoltage and undervoltage operation.

Controlled zero-bias plate current is offered in the 6883B to insure more dependable performance as a Class AB<sub>1</sub> linear rf amplifier for single-sideband suppressed-carrier service. See *Test No.3 of Characteristics Range Values*.

Also featured in the design of the 6883B is the new RCA "Dark Heater", which functions efficiently at operating temperatures 350° K below those of the heaters in conventional tube types. The dark surface of the new heater radiates heat more efficiently and improves the transfer of heat to the cathode so that optimum cathode temperature may be attained with the heater operating at approximately 1350° K.

The low operating temperature of the "Dark Heater" results in (1) lower internal stresses in the heater wire and smaller thermal change during heater warmup, (2) cooler operation of the heater which minimizes changes in heater shape and reduces the possibility of heater damage and heater shorts, (3) extremely stable heater current characteristics throughout life, and (4) significant reduction in effects of ac heater leakage.

Small in size for its power-output capability, the 6883B has a rugged button-stem construction with short internal leads, a T12 bulb, triple base-pin connections for grid No.3 and cathode (both joined to internal shield inside the tube)

to permit effective rf grounding, and an octal base with short metal sleeve having its own base-pin terminal. The sleeve shields the input to the tube and isolates it from the output circuit so completely that no other external shielding is required. Separation of input and output circuits is accomplished by bringing the plate lead out of the bulb to a cap opposite the base.

The 6883B/8032A/8552 is unilaterally interchangeable with the 6883, 6883A, and 8032.

### GENERAL DATA

#### Electrical:

Heater, for Unipotential Cathode:

Voltage (AC or DC) . . . . .	12.6	volts
Current at 12.6 volts . . . . .	0.562	amp
Minimum heating time . . . . .	60	sec

See *Special Performance Data* on page 4 for heater operation in stationary equipment and in mobile equipment.

Transconductance, for plate volts = 200, grid-No.2 volts = 200, and plate ma. = 100 . . . . . 7000  $\mu$ mhos

Mu-Factor, Grid No.2 to Grid No.1 for plate volts = 200, grid-No.2 volts = 200, and plate ma. = 100. . . . . 4.5

Direct Interelectrode Capacitances (Approx.):<sup>a</sup>

Grid No.1 to plate . . . . .	0.24 max.	pf
Grid No.1 to cathode & grid No.3 & internal shield, base sleeve, grid No.2, and heater . . . . .	13	pf
Plate to cathode & grid No.3 & internal shield, base sleeve, grid No.2, and heater . . . . .	8.5	pf

#### Mechanical:

Operating Position . . . . .	Any
Maximum Overall Length . . . . .	3-13/16"
Seated Length . . . . .	3-1/8" $\pm$ 1/8"
Maximum Diameter . . . . .	1-21/32"
Bulb . . . . .	T12
Cap . . . . .	Small (JEDEC No.C1-1)
Base . . . . .	Small-Wafer Octal 8-Pin with Sleeve (JEDEC Group 1, No.B8-150), or Small-Wafer Octal 8-Pin with External Barriers and Sleeve (JEDEC Group 1, No.B8-159)
Bulb Temperature (At hottest point) . . . . .	260 max. °C
Weight (Approx.) . . . . .	2.3 oz

### AF POWER AMPLIFIER & MODULATOR – Class AB<sub>1</sub>

CCS ICAS

Maximum Ratings, Absolute-Maximum Values:

DC PLATE VOLTAGE . . . . .	600 max.	750 max.	volts
DC GRID-NO.2 VOLTAGE . . . . .	250 max.	250 max.	volts
MAX. -SIGNAL DC PLATE CURRENT <sup>b</sup> . . . . .	175 max.	220 max.	ma
MAX. -SIGNAL PLATE INPUT <sup>b</sup> . . . . .	90 max.	120 max.	watts

	CCS	ICAS	
MAX. -SIGNAL GRID-No.2 INPUT <sup>b</sup> . . . . .	3 max.	3 max.	watts
PLATE DISSIPATION <sup>b</sup> . . . . .	27 max.	35 max.	watts
PEAK HEATER-CATHODE VOLTAGE:			
Heater negative with respect to cathode. . . . .	135 max.	135 max.	volts
Heater positive with respect to cathode. . . . .	135 max.	135 max.	volts

**Typical Operation:**

*Values are for 2 tubes*

DC Plate Voltage. . . . .	600	750	volts
DC Grid-No.2 Voltage <sup>c</sup> . . . . .	200	200	volts
DC Grid-No.1 Voltage:			
With fixed-bias source. . . . .	-47	-48	volts
Peak AF Grid-No.1-to-Grid-No.1 Voltage <sup>d</sup> . . . . .	94	96	volts
Zero-Signal DC Plate Current . . . . .	48	50	ma
Max. -Signal DC Plate Current . . . . .	250	250	ma
Max. -Signal DC Grid-No.2 Current . . . . .	14.8	12.6	ma
Effective Load Resistance (Plate to plate). . . . .	5600	7200	ohms
Max. -Signal Driving Power (Approx.) . . . . .	0	0	watts
Max. -Signal Power Output (Approx.) . . . . .	96	124	watts

**Maximum Circuit Values (CCS or ICAS):**

Grid-No.1-Circuit Resistance under Any Condition: <sup>e</sup>			
With fixed bias . . . . .	0.1 max.		megohm
With cathode bias . . . . .			Not recommended

Max. -Signal DC Grid-No.1 Current . . . . .	2.7	1.3	ma
Effective Load Resistance (Plate to plate). . . . .	3620	5200	ohms
Max. -Signal Driving Power (Approx.) <sup>f</sup> . . . . .	0.2	0.7	watt
Max. -Signal Power Output (Approx.) . . . . .	100	110	watts

**Typical ICAS Operation:**

*Values are for 2 tubes*

DC Plate Voltage. . . . .	600	750	volts
DC Grid-No.2 Voltage <sup>c</sup> . . . . .	200	150	volts
DC Grid-No.1 Voltage:			
From fixed-bias source. . . . .	-47	-39	volts
Peak AF Grid-No.1-to-Grid-No.1 Voltage . . . . .	114	110	volts
Zero-Signal DC Plate Current . . . . .	50	40	ma
Max. -Signal DC Plate Current . . . . .	328	294	ma
Max. -Signal DC Grid-No.2 Current . . . . .	26	28	ma
Max. -Signal DC Grid-No.1 Current . . . . .	3.4	7.6	ma
Effective Load Resistance (Plate to plate). . . . .	4160	6050	ohms
Max. -Signal Driving Power (Approx.) <sup>f</sup> . . . . .	0.2	0.5	watt
Max. -Signal Power Output (Approx.) . . . . .	130	148	watts

**Maximum Circuit Values (CCS or ICAS):**

Grid-No.1-Circuit Resistance: <sup>g</sup>			
With fixed bias . . . . .	30,000 max.		ohms
With cathode bias . . . . .			Not recommended

**AF POWER AMPLIFIER & MODULATOR - Class AB<sub>2</sub>**

Maximum Ratings, Absolute-Maximum Values:

	CCS	ICAS	
DC PLATE VOLTAGE. . . . .	600 max.	750 max.	volts
DC GRID-No.2 VOLTAGE. . . . .	250 max.	250 max.	volts
MAX. -SIGNAL DC PLATE CURRENT <sup>b</sup> . . . . .	175 max.	220 max.	ma
MAX. -SIGNAL PLATE INPUT <sup>b</sup> . . . . .	90 max.	120 max.	watts
MAX. -SIGNAL GRID-No.2 INPUT <sup>b</sup> . . . . .	3 max.	3 max.	watts
PLATE DISSIPATION <sup>b</sup> . . . . .	27 max.	35 max.	watts
PEAK HEATER-CATHODE VOLTAGE:			
Heater negative with respect to cathode. . . . .	135 max.	135 max.	volts
Heater positive with respect to cathode. . . . .	135 max.	135 max.	volts

**Typical CCS Operation:**

*Values are for 2 tubes*

DC Plate Voltage. . . . .	500	600	volts
DC Grid-No.2 Voltage <sup>c</sup> . . . . .	200	200	volts
DC Grid-No.1 Voltage:			
From fixed-bias source. . . . .	-46	-48	volts
Peak AF Grid-No.1-to-Grid-No.1 Voltage . . . . .	108	106	volts
Zero-Signal DC Plate Current . . . . .	50	40	ma
Max. -Signal DC Plate Current . . . . .	308	270	ma
Max. -Signal DC Grid-No.2 Current . . . . .	26	27	ma

**LINEAR RF POWER AMPLIFIER, Class AB<sub>1</sub>  
Single-Sideband Suppressed-Carrier Service**

*Peak envelope conditions for a signal having a minimum peak-to-average power ratio of 2*

	CCS	ICAS	
DC PLATE VOLTAGE. . . . .	600 max.	750 max.	volts
DC GRID-No.2 VOLTAGE. . . . .	250 max.	250 max.	volts
DC PLATE CURRENT AT PEAK OF ENVELOPE. . . . .	175 max.	220 max.	ma
PLATE DISSIPATION . . . . .	27 max.	35 max.	watts
GRID-No.2 DISSIPATION . . . . .	3 max.	3 max.	watts
PEAK HEATER-CATHODE VOLTAGE:			
Heater negative with respect to cathode. . . . .	135 max.	135 max.	volts
Heater positive with respect to cathode. . . . .	135 max.	135 max.	volts

**Typical Operation with "Two-Tone Modulation":**

*At 30 Mc*

DC Plate Voltage. . . . .	-600	750	volts
DC Grid-No.2 Voltage <sup>h</sup> . . . . .	200	200	volts
DC Grid-No.1 Voltage <sup>h</sup> . . . . .	-47	-48	volts
Zero-Signal DC Plate Current . . . . .	24	25	ma
Effective RF Load Resistance. . . . .	2800	3600	ohms
DC Plate Current at Peak of Envelope. . . . .	125	125	ma
Average DC Plate Current. . . . .	86	86	ma

	CCS	ICAS	
DC Grid-No.2 Current at Peak of Envelope . . . . .	7.4	6.3	ma
Average DC Grid-No.2 Current . . . . .	5.0	3.9	ma
Distortion Products Level: <sup>l</sup>			
Third order . . . . .	24	26	db
Fifth order . . . . .	30	31	db
Useful Power Output (Approx.):			
Average . . . . .	24.5	30.5	watts
Peak envelope . . . . .	49	61	watts

Maximum Circuit Values:  
 Grid-No.1-Circuit Resistance under Any Condition:  
 With fixed bias . . . . . 30,000 max. ohms

**PLATE-MODULATED RF POWER AMPLIFIER – Class C Telephony**

Carrier conditions per tube for use with a max. modulation factor of 1.0; at frequencies up to 60 Mc

	CCS	ICAS	
DC PLATE VOLTAGE . . . . .	480 max.	600 max.	volts
DC GRID-No.2 VOLTAGE . . . . .	250 max.	250 max.	volts
DC GRID-No.1 VOLTAGE . . . . .	-150 max.	-150 max.	volts
DC PLATE CURRENT . . . . .	145 max.	180 max.	ma
DC GRID-No.1 CURRENT . . . . .	3.5 max.	4.0 max.	ma
PLATE INPUT . . . . .	60 max.	85 max.	watts
GRID-No.2 INPUT . . . . .	2 max.	2 max.	watts
PLATE DISSIPATION . . . . .	18 max.	23 max.	watts
PEAK HEATER-CATHODE VOLTAGE:			
Heater negative with respect to cathode . . . . .	135 max.	135 max.	volts
Heater positive with respect to cathode . . . . .	135 max.	135 max.	volts

**Typical Operation:**

DC Plate Voltage . . . . .	475	600	volts
DC Grid-No.2 Voltage <sup>j</sup> . . . . .	165	175	volts
DC Grid-No.1 Voltage <sup>k</sup> . . . . .	-86	-92	volts
From a grid resistor of . 26,000		27,000	ohms
Peak RF Grid-No.1 Voltage . . . . .	106	114	volts
DC Plate Current . . . . .	125	140	ma
DC Grid-No.2 Current . . . . .	8.5	9.5	ma
DC Grid-No.1 Current (Approx.) . . . . .	3.3	3.4	ma
Driving Power (Approx.) . . . . .	0.4	0.5	watt
Power Output (Approx.) . . . . .	42	62	watts

**Maximum Circuit Values (CCS or ICAS):**

Grid-No.1-Circuit Resistance<sup>n</sup> . . . 30,000 max. ohms

**RF POWER AMPLIFIER & OSC. – Class C Telegraphy and RF POWER AMPLIFIER – Class C FM Telephony**

	CCS	ICAS	
DC PLATE VOLTAGE . . . . .	600 max.	750 max.	volts
DC GRID-No.2 VOLTAGE . . . . .	250 max.	250 max.	volts
DC GRID-No.1 VOLTAGE . . . . .	-150 max.	-150 max.	volts
DC PLATE CURRENT . . . . .	175 max.	220 max.	ma
DC GRID-No.1 CURRENT . . . . .	3.5 max.	4.0 max.	ma

	CCS	ICAS	
PLATE INPUT . . . . .	90 max.	120 max.	watts
GRID-No.2 INPUT . . . . .	3 max.	3 max.	watts
PLATE DISSIPATION . . . . .	27 max.	35 max.	watts
PEAK HEATER-CATHODE VOLTAGE:			
Heater negative with respect to cathode . . . . .	135 max.	135 max.	volts
Heater positive with respect to cathode . . . . .	135 max.	135 max.	volts

**Typical Operation as Amplifier up to 60 Mc:**

DC Plate Voltage . . . . .	600	750	volts
DC Grid-No.2 Voltage <sup>l</sup> . . . . .	200	200	volts
DC Grid-No.1 Voltage <sup>m</sup> . . . . .	-70	-77	volts
From a grid-No.1 resistor of . . . . .	24,000	28,000	ohms
Peak RF Grid-No.1 Voltage . . . . .	90	95	volts
DC Plate Current . . . . .	150	160	ma
DC Grid-No.2 Current . . . . .	10	10	ma
DC Grid-No.1 Current (Approx.) . . . . .	2.8	2.7	ma
Driving Power (Approx.) . . . . .	0.3	0.3	watt
Power Output (Approx.) . . . . .	63	85	watts

**Typical Operation as Amplifier at 175 Mc:**

DC Plate Voltage . . . . .	320	400	435	volts
DC Grid-No.2 Voltage <sup>l</sup> . . . . .	210	220	230	volts
DC Grid-No.1 Voltage <sup>m</sup> . . . . .	-52	-55	-56	volts
From a grid resistor of . 26,000		30,000	24,000	ohms
Peak RF Grid-No.1 Voltage . . . . .	65	67	73	volts
DC Plate Current . . . . .	170	180	210	ma
DC Grid-No.2 Current . . . . .	12	12	11	ma
DC Grid-No.1 Current (Approx.) . . . . .	2	1.9	2.3	ma
Driving Power (Approx.) . . . . .	2	2	3	watts
Power Output (Approx.) . . . . .	29	40	50	watts

**Maximum Circuit Values (CCS or ICAS):**

Grid-No.1-Circuit Resistance<sup>n</sup> . . . 30,000 max. ohms

**CHARACTERISTICS RANGE VALUES**

	Note	Min.	Max.	
1. Direct Interelectrode Capacitances:				
Grid No.1 to plate . . . . .	1	-	0.24	pf
Grid No.1 to cathode & grid No.3 & internal shield, base sleeve, grid No.2, and heater . . . . .	1	12.0	15.0	pf
Plate to cathode & grid No.3 & internal shield, base sleeve, grid No.2, and heater . . . . .	1	7.3	9.5	pf
2. Plate Current . . . . .	2	46	94	ma
3. Zero-Bias Plate Current . . . . .	3	330	-	ma
4. Grid-No.2 Current . . . . .	2	-	5.5	ma

Note 1: With no external shield.

Note 2: With heater voltage of 13.5 volts, dc plate voltage of 400 volts, dc grid-No.2 voltage of 200 volts, and dc grid-No.1 voltage of -34 volts.

Note 3: With heater voltage of 13.5 volts, dc plate voltage of 100 volts, dc grid-No.2 voltage of 200 volts, and dc grid-No.1 voltage of -100 volts. Grid No.1 is square-wave pulsed at 1000 kc to zero volts. Limit value is peak-pulse current.

## SPECIAL PERFORMANCE DATA ON HEATER OPERATION

## Stationary Equipment Operation:

Heater, for Unipotential Cathode:

	Min.	Design Center	Max.	
Voltage (AC or DC) <sup>a</sup> . . .	-	12.6	-	volts
Current at 12.6 volts. . .	0.525	-	0.600	amp
Useful Power Output <sup>b</sup> . . .	59	-	-	watts

<sup>a</sup> It is recommended that the design-center heater voltage be 12.6 volts; the heater power supply should not fluctuate more than 10% to insure long life.

<sup>b</sup> In a single-tube, self-excited oscillator circuit, and with ac heater voltage of 12.6 volts, dc plate voltage of 600 volts, dc grid-No.2 voltage of 200 volts, grid-No.1 resistor of 24,000  $\pm$  10% ohms, dc plate current of 150 max. ma., dc grid-No.1 current of 2.5 to 3 ma., and frequency of 15 Mc.

## Mobile Equipment Operation:

Heater, for Unipotential Cathode:

	Min.	Design Range	Max.	
Voltage (AC or DC) <sup>a</sup> . . .	-	12-15	-	volts
Current at 13.5 volts. . .	0.550	-	0.620	amp
Useful Power Output I <sup>b</sup> . . .	59	-	-	watts
Useful Power Output II . . .	See Note c			

## Overvoltage Heater Life Tests:

Continuous heater life tests are performed periodically on sample lots of tubes with 16 volts on the heater, all other electrodes "floating". Intermittent heater life tests are performed periodically on sample lots of tubes with 22 volts on the heater, a cycle of 1 minute "ON" and 4 minutes "OFF". After 1000 hours of the continuous heater life test and after 48 hours of the intermittent heater life test, the following tests are performed:

With heater voltage of 13.5 volts and  $\pm$  100 dc volts between cathode and heater, the heater-cathode leakage current will not exceed 100 microamperes.

With ac or dc heater voltage of 13.5 volts, grid-No.1 volts = -200 and cathode, grid No.2, and plate grounded, the minimum grid-No.1 leakage resistance will be 10 megohms.

With ac or dc heater voltage of 13.5 volts, plate volts = -200, and cathode grid No.1 and grid No.2 grounded, the minimum plate leakage resistance will be 10 megohms.

<sup>a</sup> It is recommended that the heater voltage operate within the range of 12.0 to 15.0 volts and within excursions from 10 to 16 volts in battery operation. See *Useful Power Output Test II* and *Overvoltage Tests*.

<sup>b</sup> In a single-tube, self-excited oscillator circuit, and with ac heater voltage of 12.6 volts, dc plate voltage of 600 volts, dc grid-No.2 voltage of 200 volts, grid-No.1 resistor of 24,000  $\pm$  10% ohms, dc plate current of 150 max. ma., dc grid-No.1 current of 2.5 to 3 ma., and frequency of 15 Mc.

<sup>c</sup> With conditions in note b above, reduce heater voltage to 10 volts. Useful power output will be at least 90% of the power output at heater voltage of 12.6 volts.

Information furnished by RCA is believed to be accurate and reliable. However, no responsibility is assumed by RCA for its use; nor for any infringements of patents or other rights of third parties which may result from its use. No license is granted by implication or otherwise under any patent or patent rights of RCA.

- a With no external shield.
- b Averaged over any audio-frequency cycle of sine-wave form.
- c Obtained preferably from a separate source or from the plate voltage supply with a voltage divider.
- d The driver stage should be capable of supplying the No.1 grids of the class AB<sub>1</sub> stage with the specified driving voltage at low distortion.
- e The type of input coupling network used should not introduce too much resistance in the grid-No.1 circuit. Transformer or impedance coupling devices are recommended.
- f Driver stage should be capable of supplying the specified driving power at low distortion to the No.1 grids of the AB<sub>2</sub> stage.
- g To minimize distortion, the effective resistance per grid-No.1 circuit of the AB<sub>2</sub> stage should be held at a low value. For this purpose the use of transformer coupling is recommended. In no case, however, should the total dc grid-No.1-circuit resistance exceed 30,000 ohms when the tube is operated at maximum ratings. For operation at less than maximum ratings, the dc grid-No.1-circuit resistance may be as high as 100,000 ohms.
- h Obtained preferably from a separate, well-regulated source.
- i Referenced to either of the two tones and without the use of feedback to enhance linearity.
- j Obtained preferably from a separate source modulated with the plate supply, or from the modulated plate supply through a series resistor.
- k Obtained from grid-No.1 resistor or from a combination of grid-No.1 resistor with either fixed supply or cathode resistor.
- l Obtained preferably from separate source, or from the plate-supply voltage with a voltage divider, or through a series resistor. A series grid-No.2 resistor should be used only when the tube is used in a circuit which is not keyed. Grid-No.2 voltage must not exceed 435 volts under key-up conditions.
- m Obtained from fixed-supply, by grid-No.1 resistor, by cathode resistor, or by combination methods.
- n When grid No.1 is driven positive and the tube is operated at maximum ratings, the total dc grid-No.1-circuit resistance should not exceed the specified value of 30,000 ohms. If this value is insufficient to provide adequate bias, the additional required bias must be supplied by a cathode resistor or fixed supply. For operations at less than maximum ratings, the dc grid-No.1-circuit resistance may be as high as 100,000 ohms.

### DEFINITIONS

AB<sub>1</sub> - The subscript 1 indicates that grid-No.1 current does not flow during any part of the input cycle.

AB<sub>2</sub> - The subscript 2 indicates that grid-No.1 current flows during some part of the input cycle.

CCS - Continuous Commercial Service.

ICAS - Intermittent Commercial and Amateur Service.

Ratings System - The maximum ratings in the tabulated data are established in accordance with the following definition of the Absolute-Maximum Rating System for rating electron devices.

Absolute-Maximum ratings are limiting values of operating and environmental conditions applicable to any electron device of a specified type as defined by its published data, and should not be exceeded under the worst probable conditions.

The device manufacturer chooses these values to provide acceptable serviceability of the device, taking no responsibility for equipment variations, environment

variations, and effects of changes in operating conditions due to variations in device characteristics.

The equipment manufacturer should design so that initially and throughout life no absolute-maximum value for the intended service is exceeded with any device under the worst probable operating conditions with respect to supply-voltage variation, equipment component variation, equipment control adjustment, load variation, signal variation, environmental conditions, and variations in device characteristics.

**Two-Tone Modulation** - Two-Tone Modulation operation refers to that class of amplifier service in which the input consists of two monofrequency rf signals having equal peak amplitude.

MAXIMUM RATINGS vs. OPERATING FREQUENCY  
In Class C Telegraphy Service

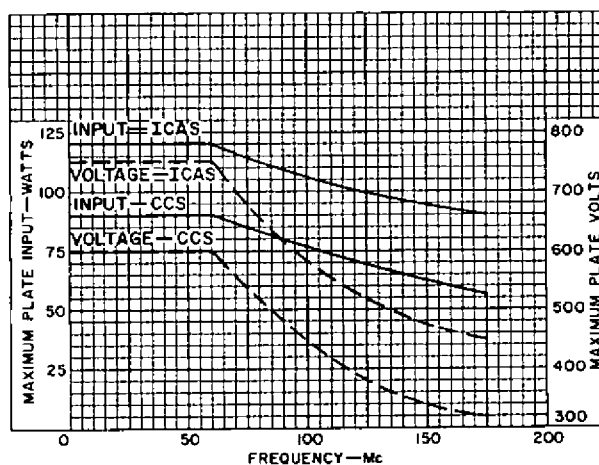

92CS-12243

Fig. 1A

MAXIMUM RATINGS vs. OPERATING FREQUENCY  
In Class C Telegraphy Service

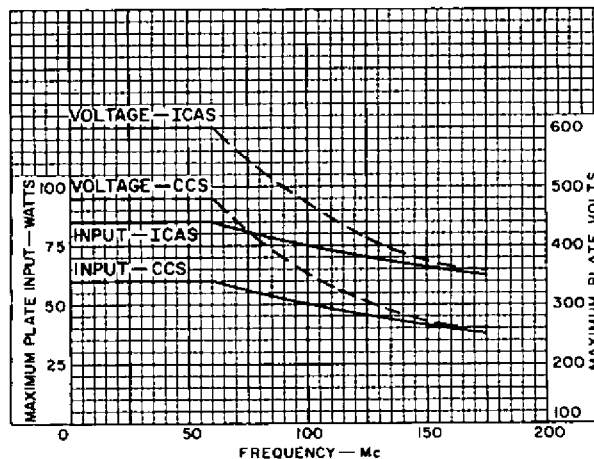

92CS-12244

Fig. 1B

**GENERAL CONSIDERATIONS**

**Temperature**

The maximum bulb temperature of 260° C is a tube rating and is to be observed in the same manner as other ratings. The temperature may be measured with temperature-sensitive paint, such as Tempilaq. The latter is made by the Tempil Corporation, 132 W. 22nd Street, New York 11, N. Y.

**TYPICAL PLATE CHARACTERISTICS**

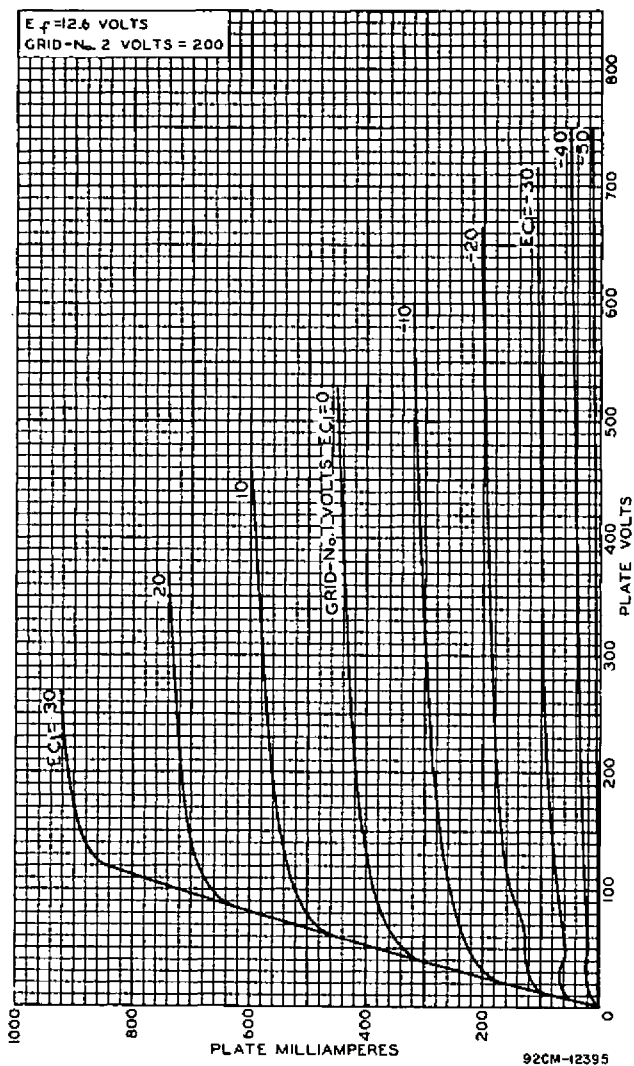

Fig. 2

**MECHANICAL CONSIDERATIONS**

**Plate Circuit**

Heavy leads and conductors together with suitable insulation should be used in all parts of the rf plate tank circuit so that losses due to rf voltages and currents may be kept at a minimum. At the higher frequencies, it is essential that short, heavy leads be used for circuit connections in order to minimize lead inductance and losses.

**TYPICAL CHARACTERISTICS**

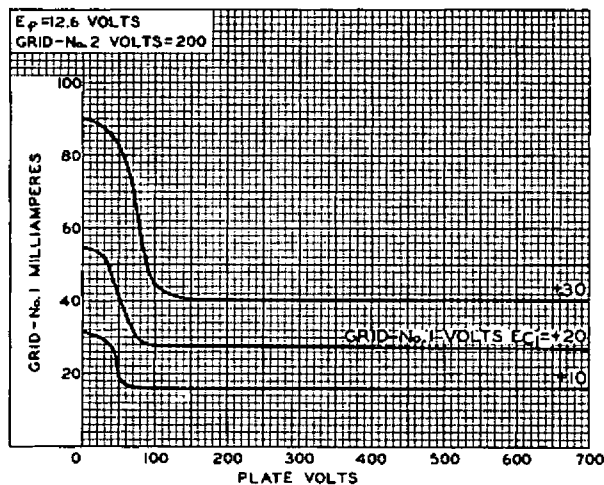

Fig. 3

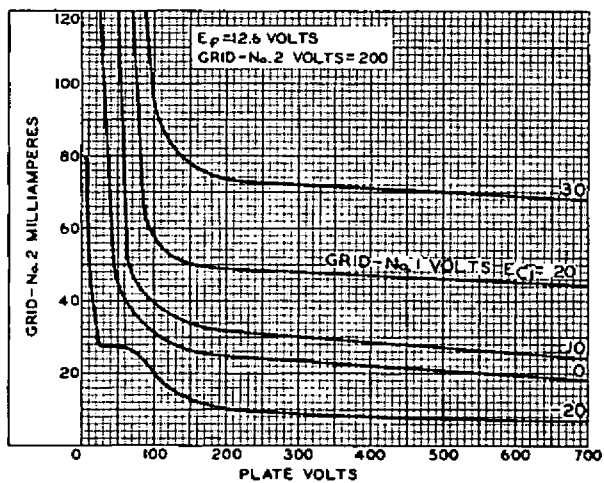

Fig. 4

To insure adequate cooling it is essential that free circulation of air be provided around the tube. In most cases, no additional air is required.

**Plate Color**

The plate shows no color when the 6883B is operated at full ratings under either CCS or ICAS conditions.

Connections to the plate should be made with a flexible lead to prevent any strain on the seal at the cap.

**ELECTRICAL CONSIDERATIONS**

**Plate and Grid No.2**

When a new circuit is tried or when adjustments are made, it is advisable to reduce the plate

voltage and grid-No.2 voltage. If the 6883B is operated at maximum-ratings and grid-No.2 voltage is obtained through a series dropping resistor, the use of a 2500-ohm protective resistor in the high-voltage supply lead is recommended. When a separate grid-No.2 voltage supply is used, a 10,000-ohm protective resistor should be connected in the grid-No.2 supply lead.

The grid-No.2 current is a very sensitive indication of plate-circuit loading and grid-No.2 current rises excessively (often to the point of damaging the tube) when the amplifier is operated without load. Therefore, care should be taken when tuning a 6883B under no-load conditions in order to prevent exceeding the grid-No.2 input rating of the tube.

TYPICAL PLATE CHARACTERISTICS

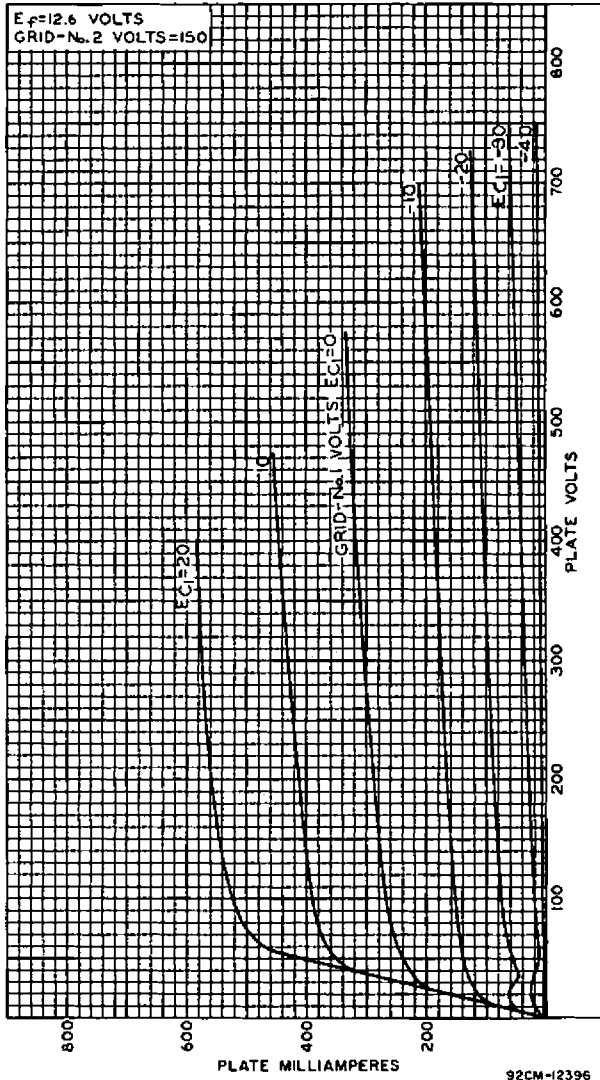
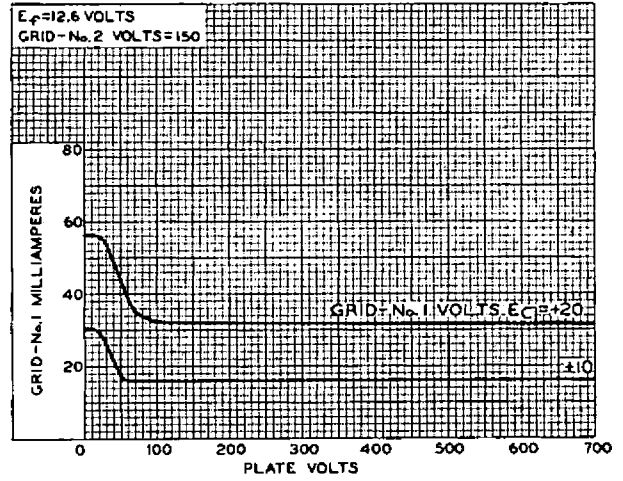

Fig.5

The plate voltage should be applied before or simultaneously with the grid-No.2 voltage; otherwise, with voltage on grid No.2 only, its current may be large enough to cause excessive grid-No.2 dissipation. A dc milliammeter should be used in the grid-No.2 circuit so that its current may be measured and the dc power input determined.

TYPICAL CHARACTERISTICS



92CS-12394

Fig.6

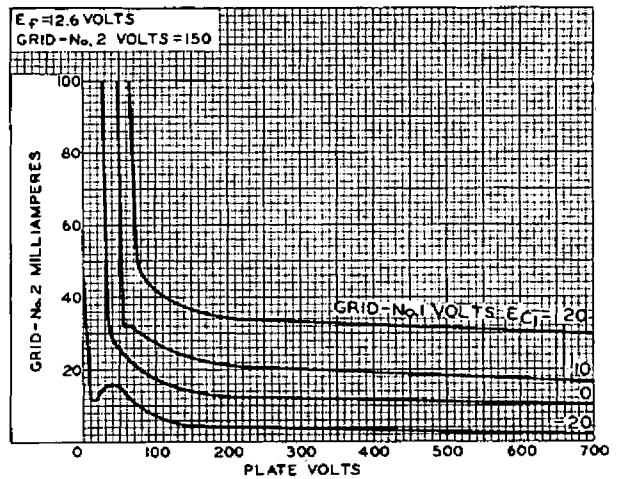

92CS-12393

Fig.7

Driver

The driver stage for the 6883B in either class C telephony or telegraphy service should have considerably more output capability than the typical driving power shown in the tabulated data in order to permit considerable range of adjustment, and also to provide for losses in the grid-No.1 circuit

and the coupling circuits. This recommendation is particularly important near the maximum-rated frequency where there are other losses of driving power, such as circuit losses, radiation losses, and transit-time losses.

#### Efficiency

Highest operating efficiency in high-frequency service, and therefore maximum power output, will be obtained when the 6883B is operated under load conditions such that the maximum rated plate current flows at the plate voltage which will give maximum rated input.

#### Class C Telephony

In plate-modulated class C amplifier service, the 6883B can be modulated 100 per cent. The grid-No.2 voltage must be modulated simultaneously with the plate voltage so that the ratio of grid-No.2 voltage to plate voltage remains constant. Modulation of the grid-No.2 voltage can be accomplished either by connecting grid No.2 through a separate winding on the modulation transformer to the fixed grid-No.2 voltage supply, or by connecting grid No.2 through an audio-frequency choke of suitable impedance for low audio frequencies to the fixed grid-No.2 supply voltage. The supply end of the choke should be well bypassed to ground.

#### Circuit Arrangements

Push-pull or parallel circuit arrangements can be used when more radio-frequency power is required than can be obtained from a single 6883B. Two 6883B's in parallel or push-pull will give approximately twice the power output of one tube. The parallel connection requires no increase in exciting voltage necessary to drive a single tube.

With either connection, the driving power required is approximately twice that for a single tube. The push-pull arrangement has the advantage of simplifying the balancing of high-frequency circuits.

When two or more tubes are used in the circuit, precautions should be taken to insure that each tube draws the same plate current.

#### Standby Operation

During standby periods in intermittent operation, the heater voltage may be maintained at normal operating value for most applications.

In those applications which require maximum reliability, it is recommended that the heater voltage be maintained at normal operating value when the period is less than 15 minutes; that it be reduced to 80 per cent of normal when the period is between 15 minutes and 2 hours; and that for longer periods, the heater voltage should be turned off.

#### Protective Devices

Protective devices should be used to protect not only the plate but also grid No.2 against overload. In order to prevent excessive plate current flow and resultant overheating of the tube, the common ground lead of the plate circuit should be connected in series with the coil of an instantaneous overload relay. This relay should be adjusted to remove the dc plate and grid-No.2 voltage when the average value of plate current reaches a value slightly higher than normal plate current. A protective device in the grid-No.2 supply should remove the grid-No.2 voltage when the dc grid-No.2 current reaches a value slightly higher than normal.

#### Precautions

The rated plate and grid-No.2 voltages of this tube are extremely dangerous. Great care should be taken during the adjustment of circuits. The tube and its associated apparatus, especially all parts which may be at high potential above ground, should be housed in a protective enclosure. The protective housing should be designed with interlocks so that personnel can not possibly come in contact with any high-potential point in the electrical system. The interlock devices should function to break the primary circuit of the high-voltage supplies when any gate or door on the protective housing is opened, and should prevent the closing of the primary circuit until the door is again locked.

#### DIMENSIONAL OUTLINE

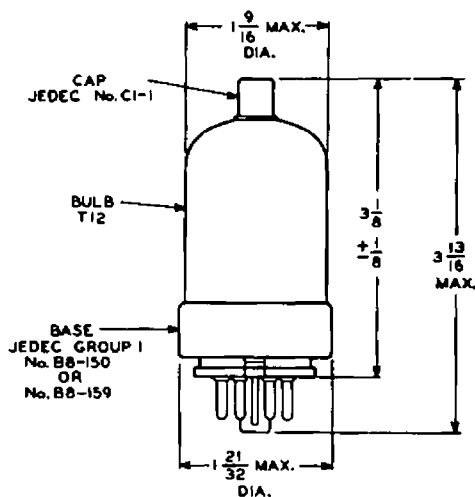

92CS-12249R1

#### TERMINAL CONNECTIONS

Bottom View

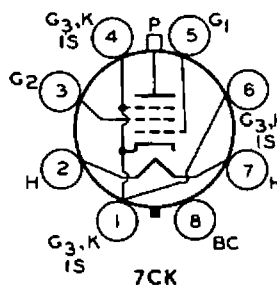
PIN 1: CATHODE, GRID NO. 3,  
INTERNAL SHIELD

PIN 2: HEATER

PIN 3: GRID NO. 2

PIN 4: SAME AS PIN 1

PIN 5: GRID NO. 1

PIN 6: SAME AS PIN 1

PIN 7: HEATER

PIN 8: BASE SLEEVE

CAP: PLATE